

Serie Idegis Domotic Industrial

Idegis Domotic Industrial Series

PoolStation®
compatible



50 gr/hr ↔ 180 gr/hr

10.000 hr
12.000 hr

pH

ORP

ppm
Cl₂

EXT

Domotic Industrial. El sistema para piscinas comunitarias

Domotic Industrial. The system for Community swimming pools

VENTAJAS / ADVANTAGES

- Prestaciones industriales a bajo coste
- Pantalla informativa LCD.
- Industrial benefits at low cost
- LCD information display.

DESCRIPCIÓN

- Menú configuración sistema.
- Auto-diagnóstico célula.
- Función test de sal.
- Panel de control integrado y porta-sondas con detector de flujo inductivo (opcional: EXT1, EXT1E y EXT-2).

DESCRIPTION

- System Setup Menu.
- Cell self-check
- Salt test function.
- Integrated control panel and probe-holder with inductive flow sensor (optional: EXT1, EXT1E and EXT-2).

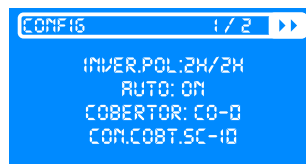
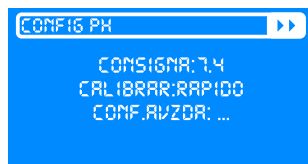
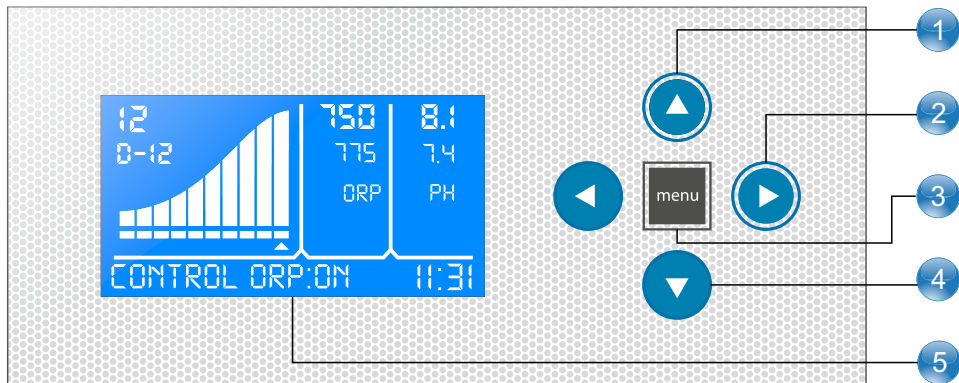

PANEL DESCRIPTIVO / PANEL DESCRIPTION

- | | |
|--|--|
| <ul style="list-style-type: none"> 1. Subir producción
Raise production 2. Navegación pantallas de control
Control screens navigation 3. Selección menú
Menu selection | <ul style="list-style-type: none"> 4. Bajar producción
Lower production 5. Pantalla de control
Control display |
|--|--|

Idegis Domotic Industrial Series

	Referencia-Reference	Producción-Production
	DOMOTIC INDUSTRIAL DOM-50	Electrolisis salina Salt electrolysis 50 gr Cl ₂ /hr
	DOM-70 DOM-90	70 gr Cl ₂ /hr 90 gr Cl ₂ /hr
	DOM-180	180 gr Cl ₂ /hr

Opción controladores
Controllers option



EXT-1



EXT-1E

Serie Idegis Domotic Industrial

Idegis Domotic Industrial Series



Fuente de Alimentación / Power Supply

Modelo / Model

Descripción/Description	DOM 50	DOM 70	DOM 90	DOM 180
Tensión de servicio / Input voltage	230 V 50/60 Hz.			
Consumo / Consumption (A ac)	1.5 A	1.8 A	2.1 A	4.2 A
Fusible / Fuse (6x32mm)	5AT	6AT	7AT	12,5AT
Salida / Output (A dc)	6 x 9 A	5 x 15 A	6 x 15 A	6 x 30 A
Producción / Production (gr Cl ₂ /hr)	45 - 50	60 - 70	80 - 90	150 -180
m ³ Piscina / Pool	Consultar guía selección / Consult selection guide			
Salinidad / Salinity	3 - 12 gr./l. (5 - 6 gr./l. recomendado / recommended) 35gr./l. Agua de mar/Seawater			
Temperatura ambiente / Room temperature	max. 40°C			
Envolvente / Enclosure	Metal			
Inversión polaridad / Polarity reversal	2 h., 3 h. y TEST (menu config.) / 2 h., 3 h. and TEST (config menu)			
Control producción / Production control	0-100%			
Detector de flujo (gas) / Flow Sensor (gas)	Sí / Yes			
Detector flujostato/inductivo /Flow-switch/inductive sensor	Opcional / Optional			
Control Producción por cobertor / Production Control by cover	Sí / Yes			
Control Producción Externo / External Production Control	Sí / Yes			
Diagnos. Electrodo / Check cell function	Sí / Yes			
Paro seguridad pH / Pump Stop	Sí, config. soft. 1 ... 99 min. / Yes, soft. config. 1 ... 99 min.			
Test salinidad (cualitativo) / Salinity test (qualitative)	Sí / Yes			
Indicador Alarma sal / Salt alarm indicators	Sí / Yes			
Menú Conf. Sistema / Setup menu	Display LCD / LCD display			
Control RS485 / Control RS485 (Modbus)	Opcional / Optional			
Poolstation® compatible	Sí / Yes			
Históricos / Logs	Sí / Yes			

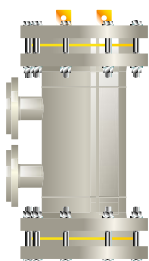

Célula de Electrolisis / Electrolysis Cell

Modelo / Model

Descripción/Description	DOM 50	DOM 70	DOM 90	DOM 180
Electrodos (titanio activado autolimpiante) / Electrodes (self-cleaning titanium activated)	Premium + : 10.000 - 12.000 hr			
Caudal mín.(m ³ /h) / Flow min. (m ³ /h)	8	12	15	30
Número de electrodos / Number of electrodes	13	6	7	13
Material	Polipropileno / Polypropylene			
Bridas conexión / Connection flanges	1"1/2	D63		D90
Presión máxima / Maximum pressure	3 Kg/cm ²			
Temperatura trabajo / Working temperature	15 - 40°C máx.			

Extensiones / Extensions

Opcional / Optional : EXT-1, EXT-1E

EXT-1	Extensión control pH-ORP integrado / Integrated pH-ORP control extension
EXT-1E	Ext. control pH-ORP int. + kit portasondas / Int. pH-ORP control ext. + sensor holder kit



Sensores de pH/ORP / pH/ORP Sensors

Descripción / Description	EXT-1, EXT-1E
Rango de media / Measure range	0.0 - 9.9 (pH) / 0 - 999 mV (ORP)
Rango de control / Control Range	7.0 - 7.8 (pH) / 600 - 850 mV (ORP)
Precisión / Precision	± 0.1 pH / ± 1 mV (ORP)
Calibración / Calibration	Automática (patrones pH-ORP) / Automatic (buffers pH-ORP)
Salidas control (pH) / Control outputs (pH)	Una salida 230 V / 500 mA (conexión bomba dosific.) / An output 230 V / 500 mA (dosing pump connection.)
Sensores pH/ORP / pH/ORP sensors	Cuerpo epoxy, unión sencilla. / Epoxy body, single bond.

Dimensiones / Dimensions

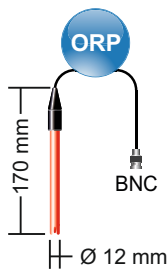
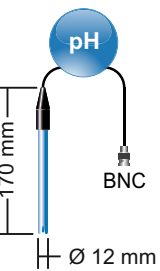
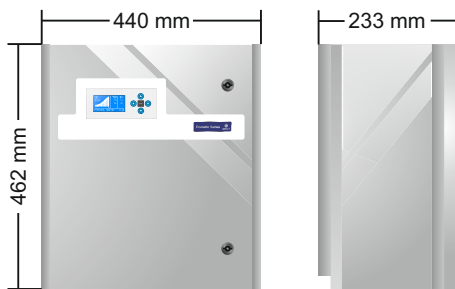
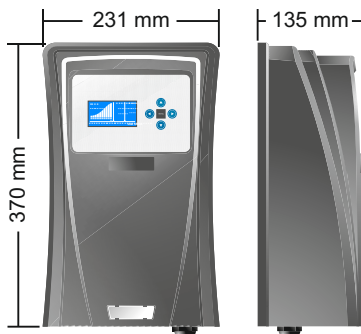

EXT-1, EXT-1E
(opcional, optional)

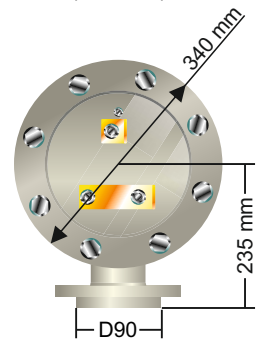

Diagrama de instalación / Installation Diagram

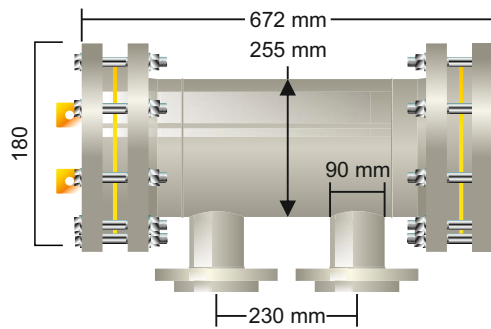
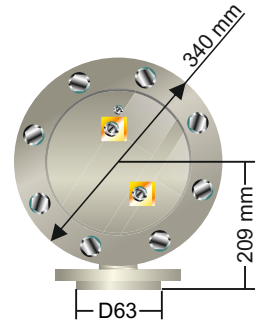
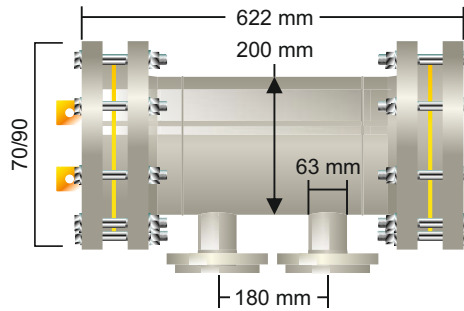
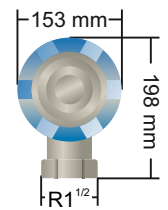
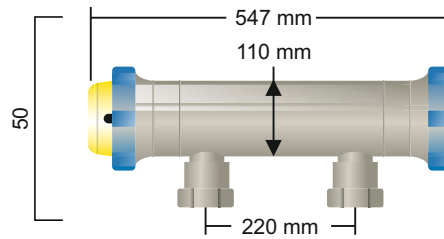